

## Safety Information

# **WARNING**

The task of servicing tires and wheels can be extremely dangerous and should be performed by trained personnel only, using the correct tools and following specific procedures. Failure to heed this warning could lead to serious injury or death. Read and understand the "Safety Information" in this catalog. We urge that the following is mandatory reading for all those involved in the servicing of tires and wheels:

Department of Labor Occupation Safety and Health Administration (OSHA) 29 CFR part 1910.177, titled Servicing of Single Piece and Multi-piece Rim Wheels. NOTE: Single piece rims have a rim made out of a single piece of material as shown on page S:12 and multiple-piece rims have a loose flange or flanges and lock ring as depicted on pages S:12 and S:7.

Rubber Manufacturers Association, "Care and Service of Farm Tires"

Rubber Manufacturers Association, "Care and Service of Off-the-Highway Tires"

Rubber Manufacturers Association, "Care and Service of Highway Truck Tires"

Rubber Manufacturers Association, "Demounting and Mounting"

Procedure Wall Charts:

Automobile and Light Truck Tires on Single piece Rims

Truck Tires (Radial and Bias ply)

Truck/Bus Tires

Agricultural Tires

We have shown step by step procedures for the servicing of single piece, three piece and five piece rims with the emphasis on safety operations for these rims in this catalog. Information on other types of rims can be found in the above RMA publications or in the catalogs published by the rim manufacturer. This and any other safety related information in Titan's catalog is issued as assistance to supervisory and operational personnel in the actual tire/rim service environment. The responsibility for implementation of this safety information rests with operational and supervisory personnel carrying out the actual service work. Read and fully understand all procedures before attempting tire/wheel servicing.

If you have any doubt about the correct, safe method of performing any step in the demounting, mounting, adding or removing fill, or inflating process **STOP!** Seek out expert assistance from a qualified person.



Wear protective gloves, footwear, safety glasses, hearing protection and head gear when servicing tires and wheels.

Further references explaining safety procedures can be found in literature published by the Rubber Manufacturers Association, Washington D.C.; the Tire Association of North America, Washington D.C.; the National Wheel and Rim Association, Jacksonville, FL; and OSHA, Washington D.C.

## **SAFETY FIRST!**

# **IMPORTANT!**

## THIS IS THE FIRST STEP IN ALL DEMOUNTING OPERATIONS

 **Always** remove the valve core and exhaust all air from a single tire and from **both** tires of a dual assembly. Check the valve stem by running a piece of wire through the stem to make sure it is not plugged.

 **READ AND FOLLOW SAFETY INSTRUCTIONS.**  
**FAILURE TO DO SO COULD RESULT IN SERIOUS INJURY.**



Removing valve core from single piece wheel.

Running wire through the stem of a single piece wheel.

## Safety Information

# GENERAL WARNINGS



This symbol indicates a warning message.



Failure to heed warnings could lead to serious injury or death.

- The task of servicing tires and wheels can be extremely dangerous and should be performed by trained personnel only, using the correct tools, and following the procedures presented here and in manufacturers' catalogs, instruction manuals, or other industry and government instruction material.
- Several types of tire changing equipment are available. Installers should be fully trained in correct operating procedures and safety instructions for the specific machine being used. Always read and understand any manufacturer's warning contained in the product literature or posted on the equipment.
- Always use approved tire and rim combinations for sizes and contours.
- Always wear personal protection equipment such as gloves, footwear, eye protection, hearing protection and head gear, when servicing tire and wheels.
- Never exceed manufacturer's recommended tire inflation pressure.
- Always use proper lifting techniques and mechanized lifting

aids to move heavy components and assemblies.

- Always take care when moving tires and wheels that other people in the area are not endangered.
- Never leave a tire, wheel or assembly unsecured in a vertical position.
- Parts that are cracked, worn, pitted with corrosion or damaged must be destroyed, discarded and replaced with good parts.
- Always exhaust all air from the tire prior to demounting.
- Never try to repair wheel, rim or tire component parts. Replace all damaged, worn or suspect parts with good parts.
- Never reinflate a tire that has lost air pressure or has been reinflated without determining and correcting its problem.
- When conducting routine tire inspections also conduct a visual inspection of wheel and rim components. Always correct any non-conformities found.
- Always use restraining devices (safety cages) when inflating tires.
- Never exceed 35 psi when seating beads.
- Misapplication, improper inflation, overloading and exceeding maximum speed may cause tire failure.
- Always inspect both sides of the tire to assure proper bead seat.



## WARNING

**15.3" DIAMETER: 9" WIDTH EUROPEAN RIMS**  
Certain European implement equipment has been imported into North America with unique diameter rims for which no North American produced replacement tire sizes are available.

Any attempt to mount and inflate 15" nominal bead diameter tires on these rims may ultimately cause one of the tire beads to break, possibly resulting in serious physical injury or even death.

The rims in question are 15.3" in diameter and 9" wide. However, rims manufactured in 1981 and earlier are marked as 15" diameter; only those manufactured in 1982 and 1983 are marked as 15.3" diameter. **The key to avoiding this potentially dangerous situation is the 9" width.** The U.S.A. (or Canada) wheel industry does not manufacture a 9" width rim for implement use.

The European tires sizes that may be mounted on these rims are:

10.0/75 – 15.3 (or 15)  
10.5/85 – 15.3  
11.5/80 – 15.3 (or 15)  
12.5/80 – 15.3

**U.S.A. (OR CANADA) PRODUCED IMPLEMENT TIRES ARE NOT TO BE MOUNTED ON ANY 9" WIDE IMPLEMENT RIM.**

## TO DETERMINE COMPATIBLE RIM WIDTH FOR TIRE SIZES

Determine the vehicle's actual rim width by measuring, in inches, the distance between the vertical bead flanges as shown. A simple ruler or yardstick may be used, as rims are manufactured in half inch increments of width.

Find permissible replacement tire sizes in RMA's Care and Service Tires Manual (Washington, D.C.). Most tires will fit on more than one rim width.

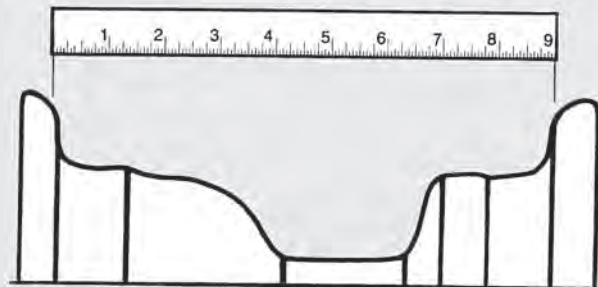

## Safety Information

# GENERAL WARNINGS

## **WARNING**

There is a danger of serious injury or death if a tire of one bead diameter is installed on a rim or wheel of a different rim diameter.

Always replace a tire with another tire of exactly the same bead diameter designation and suffix letters. For example: A 16" tire goes on a 16" rim. Never mount a 16" tire on a 16.1" or 16.5" rim. A 16.5" tire goes on a 16.5" rim. Never mount a 16.5" tire on a 16" or 16.1" rim.

While it is possible to pass a 16" diameter tire over the lip or flange of a 16.1" or 16.5" size diameter rim, it cannot be inflated enough to position itself against the rim flange. If an attempt is made to seat the tire bead by inflating, the tire bead will break with explosive force and could cause serious injury or death.

Rims of different diameters and tapers cannot be interchanged. The following diagram illustrates the difference between rims of two different tapers and diameters:

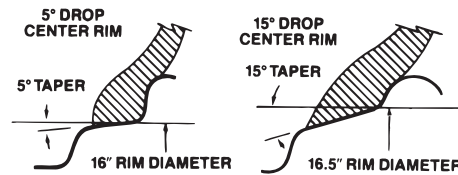

The diagram to the right shows how beads of a 16" tire will not seat on a 16.5" rim. The beads cannot be forced out against the rim flanges by using more air pressure because this will break the beads and the tire will explode with force sufficient to cause serious injury or death.

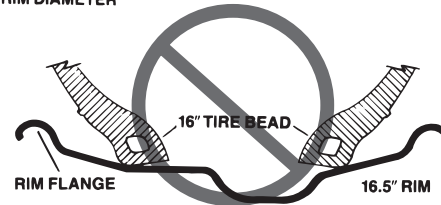

## **WARNING**

STAY OUT OF THE TRAJECTORY AS INDICATED BY SHADED AREA. ALWAYS USE A SAFETY CAGE OR OTHER RESTRAINING DEVICE IN COMPLIANCE WITH OSHA REGULATIONS.

Note: Under some circumstances, the trajectory may deviate from its expected path.

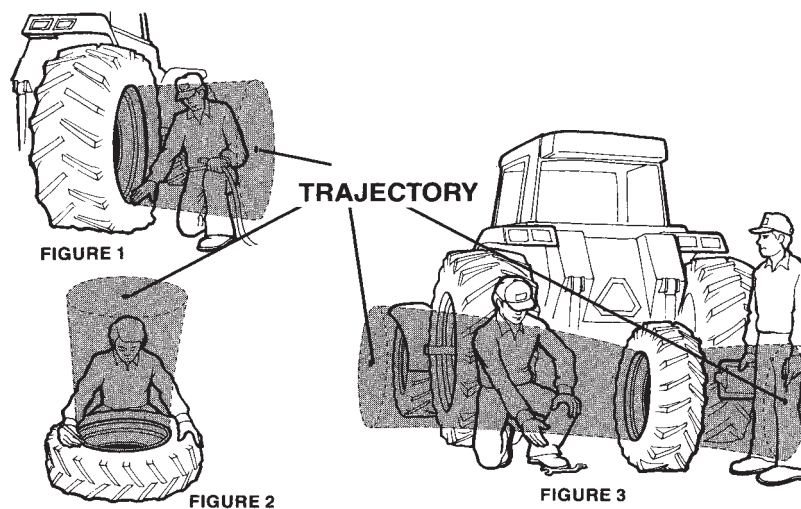

NEVER stand, lean or reach over the assembly during inflation.

## Safety Information

### Demounting Single Piece Wheel and Tire Assemblies (On-The-Vehicle)

Tools Required: Cap and core removal tools, bead unseating tool, two 36" tire irons, two 18" tire irons, approved tire mounting lubricant.

**!** If you have any doubt about the correct, safe method of performing any step in the demounting, mounting, adding or removing fill, or inflating process STOP! Seek out expert assistance from a qualified person.

**!** Due to the variety of vehicle/equipment configurations and the range of conditions and situations under which on-vehicle demounting (wheel/tire assembly still attached to vehicle or equipment) can occur, proper procedures for blocking, jacking, cribbing of the vehicle/ equipment must be done in accordance with the manufacturers operator's manual, maintenance manual or the information as provided by the vehicle/ equipment manufacturer.

Tools required: Jack, cribbing, blocking or other items as needed to jack and block the vehicle/equipment per the manufacturers instructions, hydraulic demounting tool, hooked tire iron, pry bar and lifting device or boom truck.

1. Remove the fluid fill from the tire. Deflate the tire by removing the valve core housing. For tube-type tires, remove the rim nut and push the valve through the valve hole.

**!** Always completely deflate tire (both tires of a dual assembly) by removing valve core(s) from valve(s) before attempting any demounting operation. Check the valve stem by running a piece of wire through the stem to make sure it is not plugged.

**!** Stand clear of trajectory danger zone when deflating (page S:3).



2. After the tire is completely deflated, place a hydraulic "bead unseating" tool between the tire bead and rim flange and force the bead off the bead seat. Be careful not to damage the tire's bead area. The beads should be unseated on both sides of the rim.

**!** Demounting tools apply pressure to rim flanges to unseat tire beads. Keep your fingers clear. Always stand to one side when you apply hydraulic pressure.

3. Thoroughly lubricate the tire bead area and rim flange with approved tire mounting lubricant.

**!** Never use thick or uncut tire lube. Never use antifreeze, silicones or petroleum-based lubricants.

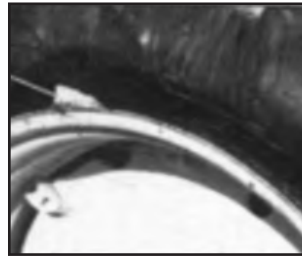

4. Lock the wheel with the valve at the top. At the bottom, force the outside bead into the well. At the top, insert long tire irons under the bead and pry the bead over the rim flange. Take small bites and avoid extremely hard prying, which will damage the tire bead.

**!** Do not release your grip on either iron, as they may spring back.

**!** Keep fingers clear of pinch points.



5. After the first section of the bead is over the rim flange, use one tire iron to pry the next section over the flange. Do not attempt to pry too large a section of the bead over the rim flange at one time. Continue prying tire over rim flange until the complete tire is on the outside of the rim flange.

**!** Do not release your grip on either iron, as they may spring back.

**!** Keep fingers clear of pinch points.



6. For tube-type tires, pull the tube out of the casing, starting at the bottom. If only the tube requires repair or replacement, this can be removed, repaired, and replaced in the tire without removing the tire completely from the wheel. Before reinstalling the tube, thoroughly inspect the inside of the casing for damage or other foreign material. Remove any remaining fluid from inside the tire.

**!** Tires or tubes with excessive or uneven wear, cracks, tears, punctures, blisters and or other damage may

## Safety Information

explode during inflation or service. If tire or tube failure potential is suspected, destroy the tire and replace with known good tire or tube of correct size, type and manufacturer for assembly, machine, and application.

7. To remove the tire completely from the wheel, insert tire irons under the inside bead at the side of the tire. Pry the rest of the inside bead over the rim flange. When starting this operation, be

sure that the bead area on the opposite side of the tire is down in the well of the rim.

 Do not release your grip on either iron, as they may spring back.

 Keep fingers clear of pinch points.

## Mounting Single Piece Wheel and Tire Assemblies (On-The-Vehicle)

Tools Required: approved tire mounting lubricant, wire brush, two 36" tire irons, two 18" tire irons, rubber mallet, extension hose with in-line gauge and clip-on air chuck, air/water inflation gauge, restraining device.

 If you have any doubt in the correct, safe method of performing any step in the demounting, mounting, adding or removing fill, or inflating process STOP! Seek out expert assistance from a qualified person.

 ALWAYS replace a tire on a rim with another tire of exactly the same rim diameter designation.

 Rims of different diameters and tapers CANNOT be interchanged.

 Remove water and foreign material from tire. Tubes or tires with excessive wear, cracks, tears, punctures, blisters, or other damage may explode during inflation or service. If tube or tire failure potential is suspected, render the tube or tire unusable and replace with known good tube or tire.



1. Thoroughly lubricate the tire bead area and rim flange with approved tire mounting lubricant.

 Never use thick or uncut tire lube. Never use antifreeze, silicones or petroleum-based lubricants.

2. With a wire brush, clean and inspect rim for fatigue cracks. Replace any cracked, badly worn, damaged and severely rusted rims or wheels. Coat the rim with paint or a rust inhibitor if necessary.

Follow procedures and safety precautions of the paint manufacturer.

Do not, under any circumstances, attempt to rework, weld, heat, or braze any rim base or wheel components.

3. Before placing tire on rim, be sure the rim's valve hole is at the bottom of wheel. Also take care to ensure directional bead tires are mounted for correct rotation direction.

4. To put the tire on the wheel, place the inner bead over the



flange at the top. Be sure the bead is not "hung up" on the bead seat, instead the bead is guided into the rim well, while the tire irons and/or rubber mallet are used to work the first bead over the rim. With the first bead on the rim, pull the tire toward the outside of the rim as far as possible to make room for the tube.

 Keep fingers clear of pinch points.

 Keep a firm grip on the tire iron(s), as they may spring back.



5. Tubeless-type tires, skip to step seven. For tube-type tires, be sure the valve is at the bottom of the wheel. Align the stem with the valve hole and starting at the bottom, place the tube in the tire. Place the valve in valve hole and screw the rim nut in place. Be sure that the tube is well inside the rim before proceeding to the next step

 If you have any doubt in the correct, safe method of performing any step in the demounting, mounting, adding or removing fill, or inflating process STOP! Seek out expert assistance from a qualified person.

6. In tube-type tires, the tube should be partially inflated and areas that contact the rim should be relubricated to prevent localized stretching.

 Never use petroleum-based lubricant. Only use approved tire mounting lubricant.

 Keep fingers clear of pinch points.

# Safety Information



7. Starting at the top, use the tire irons to lift the outer bead up and over the rim flange, then down into the rim well. Be careful not to pinch the tube in this operation.

 Keep fingers clear of pinch points.

 Do not release your grip on either iron, as they may spring back.



8. After getting the first section of the outer bead into the rim well, remove the tire iron and place one hand against that section to hold it in then pry the remainder of the bead over the flange with the tire iron in the other hand.

 Keep fingers clear of pinch points.

 Keep firm grip on tire iron(s), as they may spring back.

9. With the valve stem at the bottom, lower the jack until the tire is centered on the rim. Centering of the tire and rim assembly is extremely important to prevent broken beads.



10. Place a safety restraint over the rim and tire. Using an extension hose with an in-line air gauge and clip-on chuck (with valve core removed), inflate the tire to seat the beads. Do not exceed 35 psi. Check for correct concentric centering of tire on rim.

**For tubeless tires**, successful mounting depends on how well the shape of the tire has been maintained. If the beads are in or near their molded position, they can be seated by inflating the tire, through the valve spud. Where the beads have been squeezed together, the use of an inflator ring (either horizontally or vertically) will be required to provide a seal between the tire bead and rim.

 If assembly is incorrect, – STOP – DEFLATE – CORRECT THE ASSEMBLY – repeat procedure.

11. Raise the vehicle and rotate wheel assembly to have the valve at the top. **If the tire is tube-type**, completely deflate by removing the valve core housing to remove buckles and uneven stresses from the tube and flap before reinflation.

12. If assembly is correct, re-insert the valve core (for tube-type tires) and continue to inflate to recommend pressure.

 If assembly is incorrect – STOP – DEFLATE – CORRECT THE ASSEMBLY – repeat procedure.

 Stand clear of trajectory danger zone when inflating (page S:3).

 Never inflate beyond manufacturer's recommended tire pressure.

NOTE: A filter on the air inflation equipment to remove moisture from the airline prevents corrosion. Check the filter periodically to be sure it's functioning properly.

## Demounting Single Piece Wheel and Tire Assemblies (Off-The-Vehicle)

Tools Required: Cap and core removal tools, bead unseating tool, approved tire mounting lubricant, two 18" tire irons.

 If you have any doubt in the correct, safe method of performing any step in the demounting, mounting, adding or removing fill, or inflating process STOP! Seek out expert assistance from a qualified person.

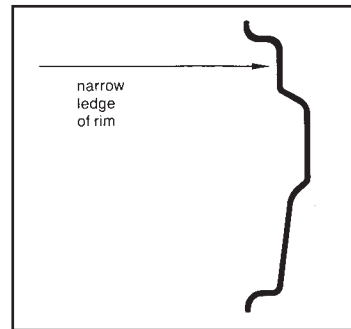

1. Remove any fill from the tire. Completely deflate tire by removing valve core from valve before attempting any demounting operation. Check the valve stem by running a piece of wire through the stem to make sure it is not plugged. Lay the assembly on the floor with the narrow ledge on the bottom.

 Stand clear of trajectory danger zone when deflating (page S:3 & S:10).

2. Drive a bead unseating tool between the tire bead and rim flange, being careful not to damage the tire bead area. After the bead has been completely released around the tire, turn the tire and rim over and repeat the bead unseating procedure with the narrow ledge up.

## Safety Information



 Keep fingers clear of pinch points.

3. With the narrow ledge on top, thoroughly lubricate the rim flange and tire bead area with an approved tire mounting lubricant.

 Never use thick or uncut tire lube. Never use antifreeze, silicones or petroleum-based lubricants.



4. Force the part of the bead that is directly across from the valve into the well. Starting at the valve, pry the bead over the rim flange using two 18" long tire irons. Take small bites to avoid damaging the bead. Continue until the top bead is completely over the rim flange.

 Keep a firm grip on tire irons as they may spring back.

 Keep fingers clear of pinch points.

5. For tube-type tires, bring the assembly to an upright position and pull the tube out of the tire. If only the tube requires repair or replacement, this can be removed, repaired, and replaced in the tire without removing the tire completely from the rim. Thoroughly inspect the inside of the casing for damage or other foreign material. Remove any remaining fluid from inside the tire.

 Tire or tubes with excessive or uneven wear, cracks, tears, punctures, blisters or other damage may explode during inflation or service. If tire or tube failure potential is suspected, destroy the tire and replace with known good tire or tube of correct size, type and manufacturer for assembly, machine, and application.

6. To completely remove the tire from the rim, turn assembly over so the narrow ledge is down and lubricate the second tire bead and rim flange. Be sure the bead still on the rim is in the rim well and insert the tire irons under the opposite side of the bead. Work the rim slowly out of the tire by taking small bites alternately using both tire irons.



 Never use petroleum-based lubricant. Only use vegetable-based lubricant.

 Keep a firm grip on the tire irons, as they may spring back.

 Keep fingers clear of pinch points.

### **Mounting Single Piece Wheel and Tire Assemblies (Off-The-Vehicle)**

Tools required: Two 18" tire irons, wire brush, locking pliers, approved tire mounting lubricant, valve retrieval tool (tube-type tires), extension hose with in-line gauge and clip-on air chuck, air/water inflation gauge, safety cage.

 If you have any doubt in the correct, safe method of performing any step in the demounting, mounting, adding or removing fill, or inflating process STOP! Seek out expert assistance from a qualified person.

 ALWAYS replace a tire on a rim with another tire of exactly the same rim diameter designation.

 Rims of different diameters and tapers CANNOT be interchanged.

 Remove water and foreign material from tire. Tubes or tires with excessive wear, cracks, tears, punctures, blisters or other damage may explode during inflation or service. If tube or tire failure potential is suspected, render the tube or tire unusable and replace with known good tube or tire.

1. With a wire brush, clean and inspect rim for fatigue cracks. Replace all cracked, badly worn, damaged and severely rusted rims and wheels. Coat the rim and components with paint or a rust inhibitor if needed.

 Follow procedures and safety precautions of the paint manufacturer.

 Do not, under any circumstances, attempt to rework, weld, heat or braze any rim base or wheel components.

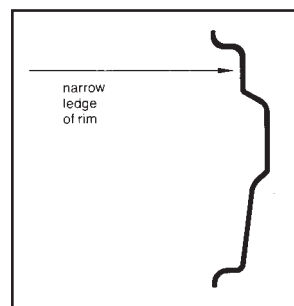

2. Lay the rim on the floor with the narrow ledge on the top. Thoroughly lubricate the tire bead area and rim flange with an approved tire mounting lubricant.

## Safety Information

-  Never use thick or uncut tire lube. Never use antifreeze, silicones or petroleum-based lubricants.



3. Push the bottom bead over the rim flange as far as possible. Use 18" tire irons to work the first tire bead completely over the rim flange, taking small bites and being careful not to damage the bead. Make sure directional tread tires are mounted for correct rotation direction.

-  Keep a firm grip on the tire irons as they may spring back.

-  Keep fingers clear of pinch points.

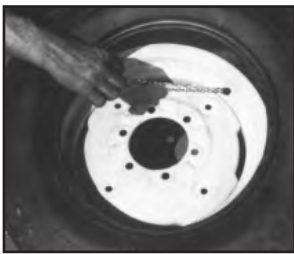

4. For tube-type tires, partially inflate the tube and insert it into the tire casing with the valve located near the valve hole in the rim. Attach a valve retrieval tool to the valve and thread the tool through the valve hole. (Inserting the tube and attaching the tool may be eased by placing a block under the tire.)

5. Starting opposite the valve, use tire irons to lever the top bead over the rim flange and down into the rim well. Be careful to avoid pinching the tube with tire irons. Locking pliers may be used to resist tire slipping back off rim.

-  Keep a firm grip on the tire irons as they may spring back.

-  Keep fingers out of pinch points.

6. When the bead is well started, lubricate the remaining unmounted portion of the tire bead and rim flange. Taking small bites, spoon the tire bead over the rim flange until the final section drops over at the valve.

-  Never use thick or uncut tire lube. Never use antifreeze, silicones or petroleum-based lubricants.

-  Keep a firm grip on the tire irons as they may spring back.

-  Keep fingers out of pinch points.



7. Thoroughly lubricate the tire bead area and rim beadseats on both sides of the tire.

Never use petroleum-based lubricant. Only use vegetable-based lubricant.

8. Centering of the tire and rim assembly is extremely important to prevent broken beads.

9. Place the tire in a safety cage. Using an extension hose with an in-line air gauge and clip-on chuck (with valve core removed), inflate the tire to seat the beads. Do not exceed 35 psi. Check for correct concentric centering of tire on rim. **For tubeless tires**, successful mounting depends on how well the shape of the tire has been maintained. If the beads are in or near their molded position, they can be seated by inflating the tire, through the valve spud. Where the beads have been squeezed together, the use of an inflator ring (either horizontally or vertically) will be required to provide a seal between the tire bead and rim.

-  If assembly is incorrect – STOP – DEFLATE – CORRECT THE ASSEMBLY – repeat procedure.

10. If the tire is tube-type, completely deflate by removing the valve core housing to remove buckles and uneven stresses from the tube and flap before reinflation.

11. If assembly is correct, re-insert the valve core and continue to inflate to recommended pressure.

-  If assembly is incorrect – STOP – DEFLATE – CORRECT THE ASSEMBLY – repeat procedure.

-  Stand clear of trajectory danger zone when inflating (page S:3 & S:10).

-  Never inflate beyond manufacturer's recommended tire pressure.

NOTE: A filter on the air inflation equipment to remove moisture from the airline prevents corrosion. Check the filter periodically to be sure it's functioning properly.



## Safety Information

### **WARNING**

The task of servicing tires and wheels can be extremely dangerous and should be performed by trained personnel only, using the correct tools and following specific procedures. Failure to heed this warning could lead to serious injury or death. Read and understand the "Safety Information" in this catalog. We urge that the following is mandatory reading for all those involved in the servicing of tires and wheels:

Department of Labor Occupation Safety and Health Administration (OSHA) 29 CFR part 1910.177, titled Servicing of Single Piece and Multi-piece Rim Wheels. NOTE: Single piece rims have a rim made out of a single piece of material as shown on page S:12 and multiple-piece rims have a loose flange or flanges and lock ring as depicted on pages S:12 and S:7.

Rubber Manufacturers Association, "Care and Service of Farm Tires"

Rubber Manufacturers Association, "Care and Service of Off-the-Highway Tires"

Rubber Manufacturers Association, "Care and Service of Highway Truck Tires"

Rubber Manufacturers Association, "Demounting and Mounting"

Procedure Wall Charts:

Automobile and Light Truck Tires on Single piece Rims  
Truck Tires (Radial and Bias ply)

Truck/Bus Tires

Agricultural Tires

We have shown step by step procedures for the servicing of single piece, three piece and five piece rims with the emphasis on safety operations for these rims in this catalog. Information on other types of rims can be found in the above RMA publications or in the catalogs published by the rim manufacturer. This and any other safety related information in Titan's catalog is issued as assistance to supervisory and operational personnel in the actual tire/rim service environment. The responsibility for implementation of this safety information rests with operational and supervisory personnel carrying out the actual service work. Read and fully understand all procedures before attempting tire/wheel servicing.

If you have any doubt about the correct, safe method of performing any step in the demounting, mounting, adding or removing fill, or inflating process **STOP!** Seek out expert assistance from a qualified person.

Wear protective gloves, footwear, safety glasses, hearing protection and head gear when servicing tires and wheels.

Further references explaining safety procedures can be found in literature published by the Rubber Manufacturers Association, Washington D.C.; the Tire Association of North America, Washington D.C.; the National Wheel and Rim Association, Jacksonville, FL; and OSHA, Washington D.C.

### **SAFETY FIRST!**

## **IMPORTANT!**

### THIS IS THE FIRST STEP IN ALL DEMOUNTING OPERATIONS

 **Always** remove the valve core and exhaust all air from a single tire and from **both** tires of a dual assembly prior to loosening the first rim clamp nut. Check the valve stem by running a piece of wire through the stem to make sure it is not plugged.

 **READ AND FOLLOW SAFETY INSTRUCTIONS. FAILURE TO DO SO COULD RESULT IN SERIOUS INJURY.**

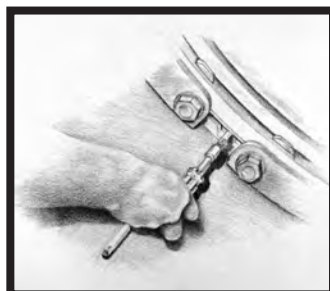

## Safety Information

# GENERAL WARNINGS



This symbol indicates a warning message.



Failure to heed warnings could lead to serious injury or death.

- The task of servicing tires and wheels can be extremely dangerous and should be performed by trained personnel only, using the correct tools, and following the procedures presented here and in manufacturer's catalogs, instruction manuals, or other industry and government instruction material.
- Always use approved tire and rim combinations for sizes and contours.
- Always wear personal protection equipment such as gloves, footwear, eye protection, hearing protection and head gear when servicing tire and wheel components.
- Never exceed manufacturer's recommended tire inflation pressure.
- Always use proper lifting techniques and mechanized lifting aids to move heavy components and assemblies.
- Always take care when moving tires and wheels that other people in the area are not endangered.
- Never leave a tire, wheel or assembly unsecured in a vertical position.
- Parts that are cracked, worn, pitted with corrosion or damaged must be destroyed, discarded and replaced with good parts.
- Always exhaust all air from the tire prior to demounting.
- Never try to repair wheel, rim or tire component parts. Replace all damaged, worn or suspect parts with good parts.
- Never reinflate a tire that has lost air pressure or has been run flat without determining and correcting the problem.
- When conducting routine tire inspections also conduct a visual inspection of wheel and rim components. Always correct any non-conformities.
- Always verify that part numbers and size designation of component parts are correctly matched for the assembly. See S:14 for part number location.
- Always place wheel and tire assemblies in restraining devices when inflating tires. See page S:17, item 11.



## WARNING

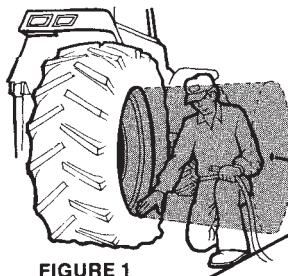

FIGURE 1



FIGURE 2

STAY OUT OF THE TRAJECTORY AS INDICATED BY SHADED AREA. ALWAYS USE A SAFETY CAGE OR OTHER RESTRAINING DEVICE IN COMPLIANCE WITH OSHA REGULATIONS.

Note: Under some circumstances, the trajectory may deviate from its expected path.

TRAJECTORY

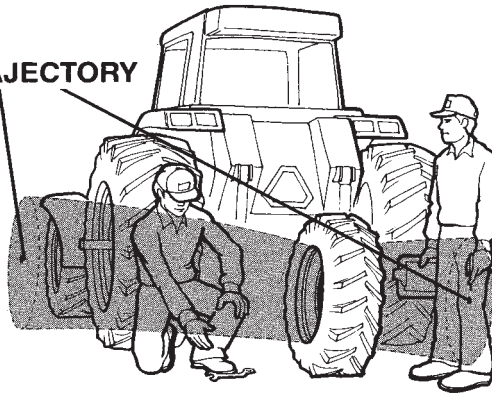

FIGURE 3



Never stand, lean or reach across the potential tire and wheel component trajectory danger zones, as shown.

- Additional safety information can be found in literature published by the Rubber Manufacturer's Association, Washington, D.C.; The National Tire Dealer and Retreading Association, Washington, D.C.; The National Wheel and Rim Association, Jacksonville, FL.; and OSHA, Washington, D.C.
- Always completely deflate the tire (both tires of a dual tire assembly) by removing the valve core(s) from valve(s) before attempting any demounting or disassembling. Check the valve stem by running a piece of wire through the stem to make sure it is not plugged.



Note: Under some circumstances, the trajectory may deviate from its expected path. Always use a safety cage or other restraining device in compliance with OSHA regulations.

## Safety Information

# Tools and Equipment Required

The following tools and equipment are required to service the various types of multi-piece rims included in this section of the catalog.

- A. Hard wood blocks
- B. A valve extension tool
- C. A set of cap and core removal tools
- D. A wire brush
- E. Chain or cable slings of adequate length

- F. Bead Lubricant (Non-Petroleum base)
- G. A mallet or its equivalent
- H. Inflation hose with clip-on chuck, in-line gauge and control valve
- I. Piece of wire (to unplug valve stem)

Plus the following:

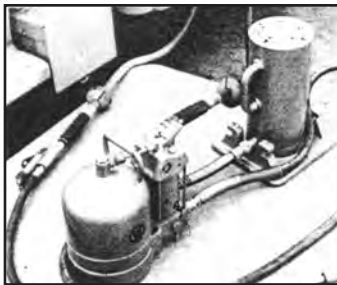

1. Air-Hydraulic Pump and 50-ton jack. Air supplied to the pump develops hydraulic pressure to lift the jack. This equipment is essential in servicing extra-heavy construction equipment.

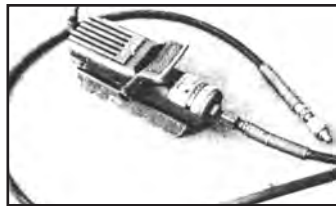

2. Air-Hydraulic Pump, activates hydraulic tools such as the bead breakers and hydraulic rams.

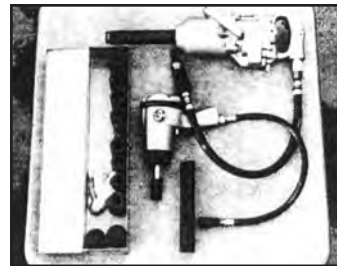

3. Air wrenches and their sockets are used to tighten and loosen nuts on wheels assemblies.

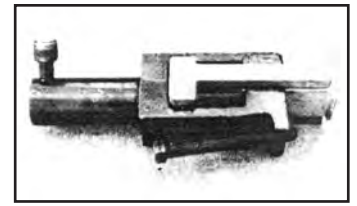

4. Bead Breaker, used for loosening tires from bead seats when the rim has prying slots.

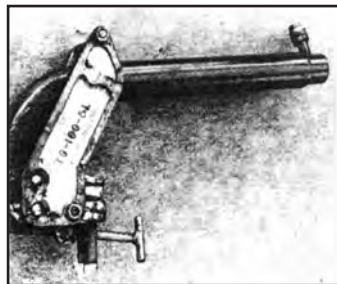

5. Bead Breaker, used for loosening tire from bead seats when the rim has no prying slots.

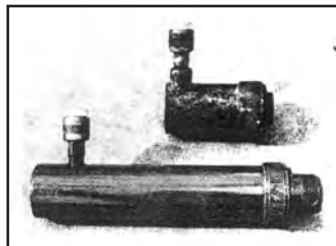

6. Top: 4" ram Hydraulic Demounting tool. Bottom: 6"-8" ram Hydraulic Demounting tool. Rams apply pressure to the inside bead flange when removing tires from 15° tapered rims.



7. Coffin hoist (1/2 ton capacity). This tool expands the bead on tapered bead seats, so that a tubeless tire will take air.

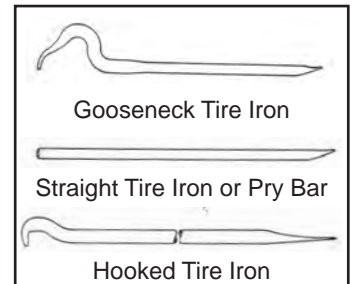

8. These tire irons are used to pry apart wheel components.



9. Mounting stand, used when mounting tires on rims that have been removed from a vehicle.



10. A service truck with a hydraulic hoist is essential to installing and removing today's heavy off-the-road tires.

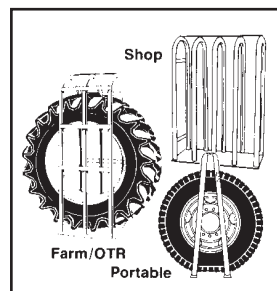

11. A cage of restraining device in which to place the wheel/tire assembly while inflating.

## Safety Information

# Identification/Terminology

### Single-Piece Rims

1. Rim Size (Nominal Bead Seat Diameter)
2. Rim Width
3. Rim Inside Dia.
4. Bead Seat Area
5. Flange
6. Flange Height
7. Valve Hole (Location and size can vary)

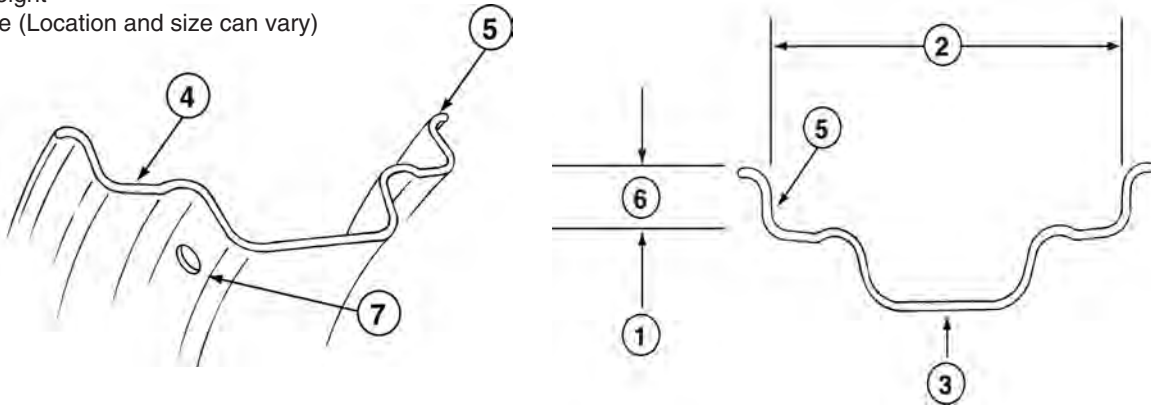

### Multi-Piece Rims (3-Piece Type)

1. Rim Size (Nominal Bead Seat Diameter)
2. Rim Width
3. Rim Inside Dia.
4. Bead Seat Area
5. Flange-Fixed
6. Flange Height
7. Valve Hole (Location and size can vary)
8. Flange-Removable (Side Ring)
9. Lock Ring
10. O-Ring (For tubeless application only)
11. 28° Mounting Bevel (utilized for demountable application only)
12. Rim Stop Plate (Used for demountable application only; size, shape and location can vary.)
13. O-Ring Groove
14. Lock Ring Groove
15. Gutter portion of rim

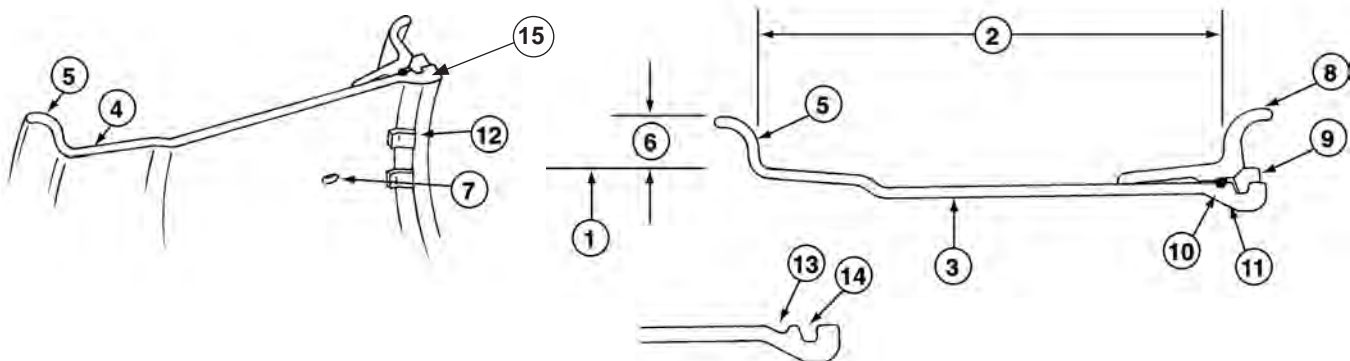

# Safety Information

## Multi-Piece Rims (5-Piece Type)

1. Rim Size (Bead Seat Diameter)
2. Rim Width
3. Rim Inside Dia.
4. Back Flange Portion of Rim Base
5. Center Band Portion of Rim Base
6. Gutter Band Portion of Rim Base
7. Rim Base (Entire Shaded Area)
8. Bead Seat Band (Removable, Gutter Side only)
9. Lock Ring
10. O-Ring
11. Flange, Inner (Removable)
12. Flange, Outer (Removable) \*Note: Inner and Outer Flanges are identical

13. 28° Mounting Bevel (Utilized for demountable application only)
14. Valve Hole (Location, size and configuration can vary)
15. Knurl (Located on Back Flange Portion of Rim Base and Bead Seat Band tire mating surfaces)
16. O-Ring Groove
17. Lock Ring Groove (size and shape can vary depending on style of lock ring)
18. Pry Bar Pocket [not shown] (continuous gap entire circumference on some items)

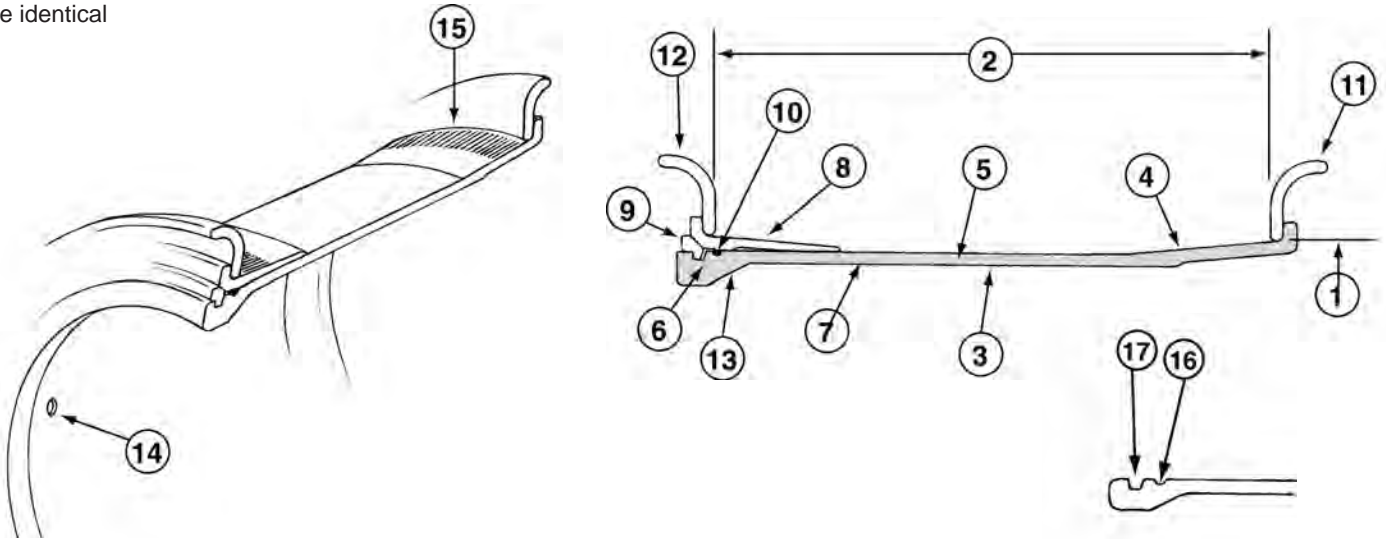

## Multi-Piece Rims (5-Piece Type)

### Crimped on Style Driver

1. Lock Ring
2. Crimped on driver
3. Notch in gutter portion of rim
4. Notch in bead seat band

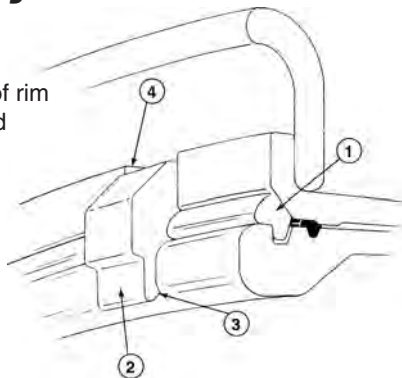

### Loose Style Driver

1. Driver Pocket (Welded on gutter portion of rim base)
  2. Driver Pocket
  3. Driver Key\*
- \*Note: See page 5:13

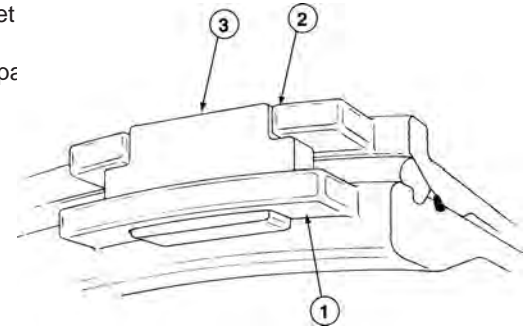

## Demountable Type Rims

1. Gutter Portion of Rim Base
2. 28° Mounting Bevel
3. Rim Stop Plates (location, style and size can vary)

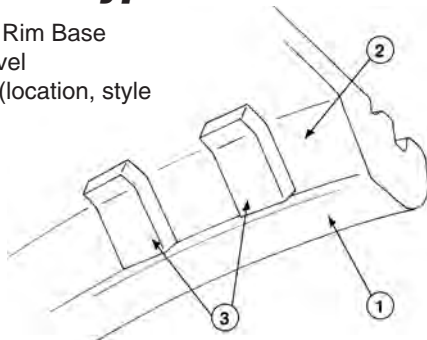

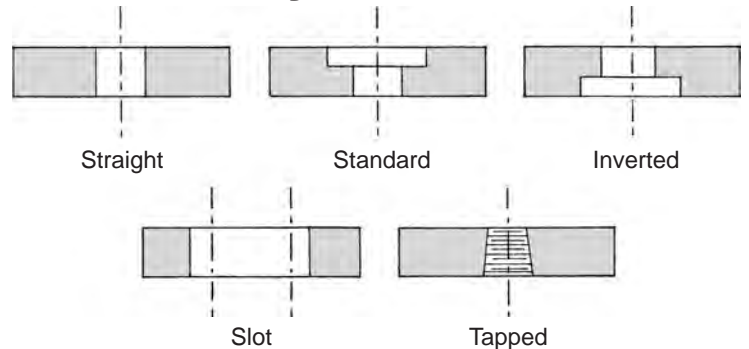

## Valve Hole Styles



# Safety Information

## Titan “W” Series Rims are not interchangeable with other types

-  If you have any doubt about the correct, safe method of performing any step in the demounting, mounting, or inflating process STOP! Seek assistance from a qualified person.
-  Rim and Wheel Components are not always interchangeable check part numbers carefully before assembling.
-  Titan’s “W” SERIES LOCK RINGS ARE NOT INTERCHANGEABLE WITH OTHER TYPES, it is vitally important that you must check part numbers carefully before rim assembly. Following is a summary of the changes.

### “W” Style Lock Ring

A “W” appears after the part number, which is stamped on the 45 degree face near the lock ring split (e.g. LR49W for a 49” rim), see illustration below.

A circumferential groove gives the ring a unique appearance. This lock ring can only be used with the new “W” style gutters.

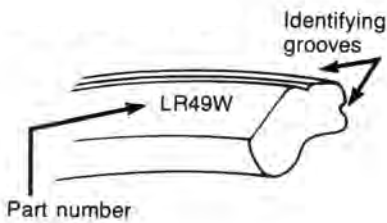

### “W” Style Rim Base

There are two types of rim bases, the old version contains a “T” in the part number, whereas the new style contains a “W.” A “W” style rim base must be matched only with a “W” style lock ring.

OLD	NEW
B1735HTHGD	B1735RWHGD
B3239HTEL	B3239RWEL



The faces of the “W” style rim base carries a caution stamping advising the user of the proper lock ring part number.

### Bead Seat Bands

There are two types of bead seat bands, the old version contains an “H” in the part number, whereas the new style contains an “R.” These bead seat bands are interchangeable.

The R and H Bead Seats are interchangeable.

OLD	NEW
BB49HTG	BB49RTG
BB39HTL	BB28RTL

## DO NOT MISMATCH LOCK RINGS AND RIM BASES

### Correct Assembly:

“W” style lock ring with grooves assembled with “W” style rim base.

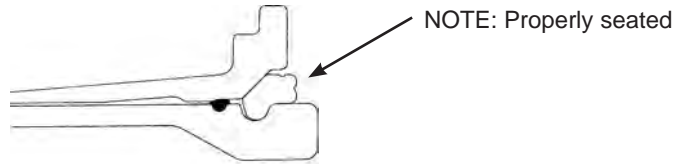

### Incorrect Assembly:

“W” lock ring with old rim base. Note poor fit and gap between lock ring and gutter. DO NOT USE. REASSEMBLE USING PROPER COMPONENTS.

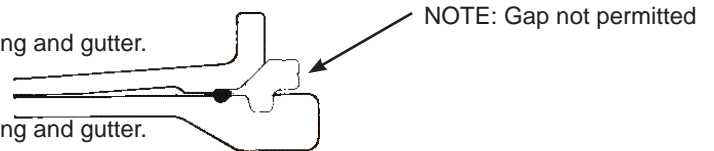

“W” lock ring with old rim base. Note poor fit and gap between lock ring and gutter.

### Incorrect Assembly:

DO NOT USE. REASSEMBLE USING PROPER COMPONENTS.

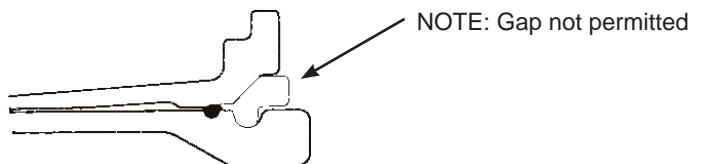

## Safety Information

# Outboard Driver Keys

## Instructions

**!** If you have any doubt about the correct, safe method of performing any step in the demounting, mounting, or inflating process STOP! Seek assistance from a qualified person.

## Outboard Driver Keys

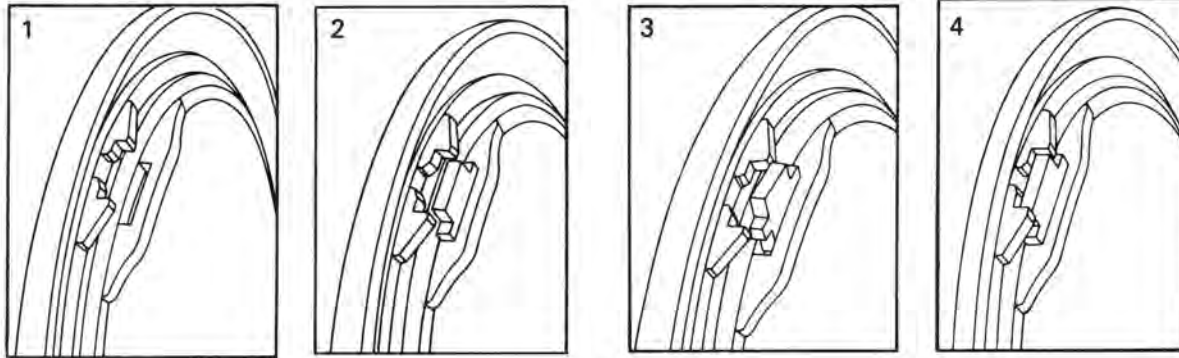

1. Align driver pockets in bead seat band and base as shown.
2. Inset driving key into driver pocket on base.
3. Make certain that all parts are properly aligned, as shown, before inflation.
4. When properly aligned, the bead seat band and pocket will move out and lock the driver key during inflation.

Outboard drivers are on those rims used in high torque and/or low inflation pressure applications, preventing circumferential movement of the rim components. Rim assemblies with an "M" or "L" near the end of the style designation (part number) are so equipped.

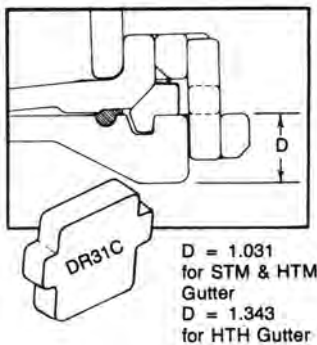

The DR31C driver key is used on rim bases with 1.0" and 1.3" approximate thickness gutter sections; basic styles STM, HTM, HTHM and HTHL.

D = 1.031  
for STM & HTM  
Gutter  
D = 1.343  
for HTH Gutter

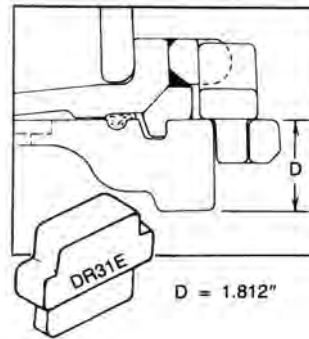

The DR31E driver key is used on rim bases with the 1.8" approximate thickness gutter section; basic style HTEL.

D = 1.812"

## Demounting Tires from Titan Assemblies

### 3-Piece Rim Assemblies

Tools Required: One (1) straight tire iron tool; Two (2) gooseneck tire iron tools; Rubber lubricant; Rubber, lead, plastic or brass-faced mallet and valve core removal tool, wire.

**!** The task of servicing tires and wheels can be extremely dangerous and should be performed by trained personnel only, using the correct tools and following specific procedures. If you have any doubt about the correct, safe method of performing any step in the demounting, mounting, or inflating process STOP! Seek assistance from a qualified person.

**!** Always completely deflate tire (both tires of a dual assembly) by removing valve core(s) from valve(s) before attempting any demounting operation. Check the valve stem by

running a piece of wire through the stem to make sure it is not plugged.

**!** Stand clear of trajectory danger zone when deflating (p. S:3 & S:10).

1. After complete deflation, place the assembly on the floor (on blocks with loose side flange side up).

2. Drive the goose-necked end of two gooseneck tire iron tools between the tire and side flange about 5 inches apart.

3. Pry both tools down and out as shown. Leave one tool in position and place the second about 5 inches beyond. Repeat

## Safety Information



in successive steps until the tire bead is completely unseated.

 Never release your grip on the tire irons, as they may spring back.

4. After the tire bead is unseated, stand on side flange and tire sidewall to depress the side flange down along the rim base. Pry the lock ring loose, starting at the split then remove the lock ring.

 Keep fingers clear of pinch points.





5. Hold the side flange down with hooked end of gooseneck tire iron to remove the "O" ring from ring groove. It is a good idea to cut and discard the "O" ring and replace it with a new "O" ring.

 Keep fingers clear of pinch points.

6. Remove the side flange.

7. Turn tire and rim over and unseat second bead by inserting both gooseneck tire iron tools between tire and fixed rim flange as in step 3. Repeat steps 2 and 3 until the tire bead is completely broken loose from the rim on the fixed flange side. Lift rim base out of tire.

 Do not release your grip on the tire irons, as they may spring back.

 Keep fingers clear of pinch points.

## Mounting Tires on Titan Assemblies 3-Piece Rim Assemblies

Tools Required: One (1) straight tire iron tool; Two (2) gooseneck tire iron tools; Rubber lubricant; Rubber, lead, plastic or brass-faced mallet and safety cage.

 The task of servicing tires and wheels can be extremely dangerous and should be performed by trained personnel only, using the correct tools and following specific procedures. If you have any doubt about the correct, safe method of performing any step in the demounting, mounting, or inflating process STOP! Seek assistance from a qualified person.

1. Clean the rim base and all components thoroughly with a wire brush to facilitate inspection, maintenance and mounting.

 Clean all dirt and rust from inter-locking faces of multi-piece rim components particularly the gutter sections which hold the lock ring and "O" ring in place. Failure to adequately clean all components will inhibit efforts to inspect, maintain, and reassemble the tire and wheel correctly.

2. Inspect rim base and wheel components for cracks, wear, corrosion and damage.

 Parts that are cracked, worn, pitted with corrosion, or damaged must be destroyed and replaced with good parts.

 In situations where part condition is suspect or in doubt destroy the part, discard and replace with good part.

 Do not, under any circumstances, attempt to rework, weld, heat, or braze any rim base or wheel components.

 Verify that the replacement parts are the correct size and type and manufacturer for the wheel being assembled.

3. After the rim and wheel component inspection is complete, and rim base and wheel components are verified to be in good usable condition, repaint all bare metal with a rust inhibitor to retard detrimental effects of corrosion.

 Follow procedures and safety precautions of the paint manufacturer.

4. Inspect the tire for wear, cracks, tears, punctures and other damage.



## Safety Information

 Tires with excessive or uneven wear, cracks, tears, punctures, blisters or other damage may explode during inflation or service and tire should be destroyed and replaced with good tire of correct size, type and manufacturer for assembly, machine, and application.

 If in doubt of the condition of the rim base, wheel components, or tire - STOP - contact the manufacturer or distributor for assistance.

 Make sure parts are clean, repainted if necessary and have been inspected for damage and cracks before proceeding with mounting.

 Parts that are cracked, worn, pitted with corrosion, or damaged must be rendered unusable, discarded and replaced with good parts.

5. Install valve spud on rim.

 Follow valve spud manufacturer's recommendations and installation instructions.



6. Place rim base on blocks with fixed flange side down. Lubricate both bead seats of the tire with vegetable base lubricant. Place tire over rim base.

 Never use petroleum-based lubricant; use vegetable-based lubricant only.

7. Place side flange over rim base and push straight down with hands as far as possible. Make sure side flange does not bind on rim base.

 First, double check to make sure correct parts are being assembled, then proceed.

 Keep fingers clear of pinch points.



8. Lubricate a new rubber "O" ring. Place "O" ring in groove on one side and stretch "O" ring snapping it into place rather than rolling it into place. Then lubricate the entire "O" ring area. (NOTE: It may be necessary to hold the side flange down with

the flat end of the gooseneck tire iron tool in order to expose the "O" ring groove.)

 Keep fingers clear of pinch points.

 Tire mounting 20" bead diameter and larger or flat base rims - lube the bead and rim flange area with water only. 15" and 16.1" - drop center rims use a very thin vegetable oil soap solution on both beads and rim flanges. Never use thick or uncut lube. Never use antifreeze, silicones or petroleum-based lubricants.



9. Stand on side flange to position it below both grooves in the rim base and snap lock ring into lock ring (upper) groove. Be certain the lock ring is installed with the correct side facing the operator as illustrated on page S:15.

10. Check components to make sure that parts are correctly assembled. (NOTE: Lock ring should be fully seated in gutter.)

 Lock Ring must be properly seated in gutter, see p. S:15.

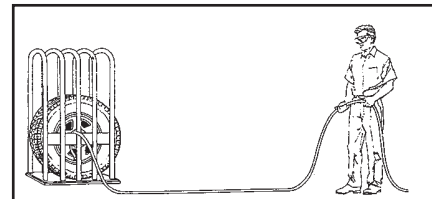

11. Place rim and tire in a safety cage during tire inflation. Stand to the side of the tire during inflation as illustrated. Inflate to approximately 3 psi and again check for proper engagement of all components. If assembly is correct, continue to inflate to recommended pressure.

 Stand clear of potential trajectory danger zone (see diagram). Refer to page S:3 & S:10.

NOTE: It is advisable to use a clip-on chuck with an in-line pressure gauge and enough air line hose to permit the person inflating the tire to stand clear of the potential trajectory danger zone.

 If assembly is incorrect STOP-DEFLATE-CORRECT THE ASSEMBLY-AND REPEAT PROCEDURE.

 Never attempt to align or seat side flange, lock ring or other components by inflation, hammering, welding, heating or brazing.

NOTE: A filter on the air inflation equipment to remove moisture from the air line prevents corrosion. Check the filter periodically to be sure it's functioning properly.

 Never inflate beyond manufacturer's recommended tire pressure.

## Safety Information

# Demounting Tires on Titan Assemblies

## 5-Piece Rim Assemblies

Tools Required: hydraulic demounting tool and two straight tire irons, screwdriver, piece of wire.

**!** The task of servicing tires and wheels can be extremely dangerous and should be performed by trained personnel only, using the correct tools and following specific procedures. If you have any doubt about the correct, safe method of performing any step in the demounting, mounting, or inflating process STOP! Seek assistance from a qualified person.

**!** Always completely deflate tire (both tires of a dual assembly) by removing valve core(s) from valve(s) before attempting any demounting operation. Check the valve stem by running a piece of wire through the stem to make sure it is not plugged. Remove driving key if present. See page S:16.

1. Place the assembly gutter side up on blocks.



2. Remove the lock ring, using two tire irons (NOTE: If this is not possible, the tire bead may be unseated as shown in step 4 with the lock ring and "O" ring in place. However, these items must be removed before removal of bead seat bands and flanges in step 7).

**!** Keep fingers clear of pinch points.

**!** Do not release your grip on the tire irons, as they may spring back.



3. Remove the "O" ring by prying the bead seat band back and inserting a pry bar or screwdriver under the "O" ring and pulling it from the groove. It is good practice to cut and discard the "O" ring and replace with a new "O" ring.

**!** Keep fingers clear of pinch points.

4. Place hook of the hydraulic demounting tool into one of the pry bar pockets. A continuous lip is provided on some bases. Adjust the ram adjusting screw to enable the tool to remain vertical when under pressure. In some cases, the pressure foot may have to be removed to ensure a good hold. Activate

the hydraulic pump and apply pressure. If necessary, release pressure and readjust the ram adjusting screw. Depress flange about 1/2"-3/4" and place a nut or similar object between the flange and the lip of the bead seat band by laying it on the rim flange and sliding it into position with a screwdriver.

**!** Keep fingers clear of pinch points.

**!** Always stand to one side of the tool and hold it with one hand. This allows control should the tool not seat properly and fly off.

5. Release the pressure and move about 2 feet around the rim or to the next pocket for the second bite. Continue the procedure until the tire bead is unseated.



Do not use tool in the vicinity of the butt weld area of the bead seat band, the flanges, or rim base.

6. Remove bead seat band using hoist or pry bars.

**!** Keep fingers clear of pinch points.

7. Remove outer flange (ref. p. S:7) using a hoist or pry bars.

**!** Always stand clear when using mechanical lifting devices.



8. Turn assembly over and repeat tire bead unseating procedure on the back side. (Steps 4 & 5)

9. Lift rim base from tire using hoist.

10. Remove inner flange. (ref. p. S:7)



In some cases it may be advantageous to use a more powerful hydraulic demounting tool with a longer stroke. However, caution must be used to avoid bending the flange or breaking the butt weld. Follow procedure outlined in step 4.

**!** If the flange or butt weld are damaged, destroy the parts, discard, and replace with good parts.

## Safety Information

# Mounting Tires on Titan Assemblies

## 5-Piece Rim Assemblies

Tools Required: Rubber, lead, plastic or brass-faced mallet; rubber lubricant, mounting machine to depress beads, if necessary and safety cage.

**!** The task of servicing tires and wheels can be extremely dangerous and should be performed by trained personnel only, using the correct tools and following specific procedures. If you have any doubt about the correct, safe method of performing any step in the demounting, mounting or inflating process STOP! Seek assistance from a qualified person.



1. Before mounting, always clean all rim components, removing rust and dirt, especially from the lock ring groove and "O" ring groove to insure proper seating and seal. Inspect parts for damage. Replace all cracked, badly worn, damaged and severely rusted components; paint or coat all parts with a rust inhibitor. Double check to be sure correct parts are being assembled. Also inspect the tire for foreign matter.

**!** Tires with excessive or uneven wear, cracks, tears, punctures, blisters or other damage could explode during inflation or service. Discard the tire and replace with good tire of correct size, type and manufacturer for assembly, machine and application.

**!** Follow procedures and safety precautions of the paint manufacturer.

**!** Parts that are damaged or suspected of being damaged must be destroyed, discarded and replaced with good parts.

**!** Do not attempt to rework, weld, heat or braze any rim base or wheel components.



2. Place rim base on blocks (4" to 6" high) on floor, gutter side up. Place inner flange (ref. p. S:7) on rim base, lubricate tire beads with vegetable lubricant. Place tire on rim using tire handler or hoist with sling.

**!** Never use petroleum-based lubricant; use vegetable based lubricant only.

3. Depress the tire so that the lower tire bead is driven onto the back 5° Bead Seat taper of the rim. This will expose more of the gutter at the upper side of the rim base to facilitate assembly.



4. Place the outer flange (ref. p. S:7) over the rim base on the tire.

**!** Keep fingers clear of pinch points.



5. Place the bead seat band on the rim base. If present, driver pockets must be aligned. See page S:16. Due to limited clearance between bead seats and rim base, bead seat band will bind if cocked slightly. Band should slide freely over base.

**!** DO NOT HAMMER BEAD SEAT BAND INTO PLACE!

**!** If necessary, remove and re-install, or use rubber-, lead-, plastic- or brass-faced mallet to tap, lightly upward on the bead seat band in order to get it to seat properly.



6. Place a new, lubricated "O" ring into the "O" ring groove, then lubricate the entire "O" ring area with an approved vegetable-base lubricant. Snap "O" ring into place by placing in groove on one side, stretching like rubber band and seating on opposite side.

**!** Never use petroleum-based lubricant; use vegetable based lubricant only.

**!** Keep fingers clear of pinch points.

## Safety Information



7. Start the lock ring in the lock ring groove and push or walk it into place.

 Keep fingers clear of pinch points.



8. Insert drive key as required in pockets. See page S:16.

 Never exceed the manufacturer's recommended inflation pressure.

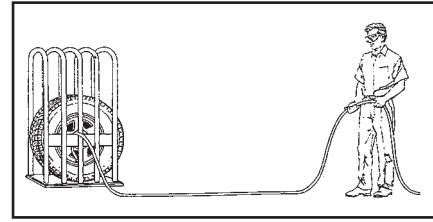

9. Place rim and tire in a safety cage during tire inflation. Stand to the side of the tire during inflation as illustrated. Inflate to approximately 3 psi and again check for proper engagement of all components. If assembly is correct, continue to inflate to recommended pressure.

 Stand clear of potential trajectory danger zone (see diagram page S:3 & S:10).

NOTE: It is advisable to use a clip-on chuck with an in-line pressure gauge and enough air line hose to permit the person inflating the tire to stand clear of the potential trajectory danger zone.

 If assembly is incorrect, STOP-DEFLATE-CORRECT THE ASSEMBLY-AND REPEAT PROCEDURE.

 Never attempt to seat rings or other components or correct components alignment by hammering, welding, heating or brazing while tire is inflated, partially inflated or deflated.

## On-Vehicle Demounting of Tires from Titan 5-Piece Rim Assemblies

 Due to the variety of vehicle/equipment configurations and the range of conditions and situations under which on-vehicle demounting (wheel/tire assembly still attached to vehicle or equipment) can occur, proper procedures for blocking, jacking, cribbing of the vehicle/equipment must be done in accordance with the manufacturer's operator's manual, maintenance manual or the information as provided by the vehicle/equipment manufacturer.

Tools required: Hydraulic Demounting Tool; Hooked Tire Iron; Pry Bar; lifting device or boom truck; and valve core removal tool; jack, cribbing, blocking or other items as needed to jack and block the vehicle/equipment per the manufacturer's instructions.

 The task of servicing tires and wheels can be extremely dangerous and should be performed by trained personnel only, using the correct tools and following specific procedures. If you have any doubt about the correct, safe method of performing any step in the demounting, mounting or inflating process STOP! Seek assistance from a qualified person.

1. Jack, crib and block the vehicle/equipment per the manufacturer's instructions.

 Jacking, cribbing and blocking a vehicle/equipment can be hazardous. You must refer to the manufacturer's operator's or maintenance manual for proper procedures.

 Always completely deflate tire (both tires of a dual assembly)

by) by removing valve core(s) from valve(s) before attempting any demounting operation. Check the valve stem by running a piece of wire through the stem to make sure it is not plugged.

Remove driving key if present.



2. Place the hook of the hydraulic demounting tool into one of the pry bar pockets. A continuous lip is provided on some bases. Adjust the ram adjusting screw to enable the tool to be perpendicular to the wheel when under pressure.

 Always stand to one side of the tool and hold it with one hand. This allows control should the tool not seat properly and fly off.

3. Apply pressure and depress the flange about 3/4." If necessary release the pressure to readjust the tool. Place the end of a hooked tire iron between the flange and the lip of the bead seat band and release the pressure. Now place the hook of the hydraulic demounting tool under the lip of the bead seat band and continue the procedure around the rim; then slowly apply

## Safety Information

pressure until the tire bead is COMPLETELY unseated.

4. Remove driving key if present. See page S:16.



5. Remove the lock ring with a pry bar, starting near the split and working around the ring.

 Never release grip on pry bars or tire irons when working on wheel-tire assemblies, as they may spring back.

 Keep fingers clear of pinch points.



6. Insert the tip of a hooked tire iron under the "O" ring and pull it from the groove. It is good practice to destroy the old "O" ring to insure that a new "O" ring will be used.

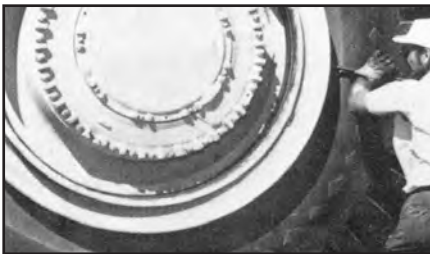

7. Use a hooked tire iron under the flange to pry the bead seat band loose, with assistance of lifting device, carefully lower the bead seat band to the ground and roll it out of the way.

 Use mechanical lifting device to avoid injury.



8. With assistance or a lifting device, remove the outer flange, then carefully lower it to the ground and roll it out of the way.

 Use mechanical lifting device to avoid injury.



9. To unseat the inner tire bead, use either the hydraulic demounting tool as used on the outer bead or a shorty ram between the frame of the vehicle and the back flange, as shown.



10. Remove the tire using a boom truck and sling or a tire handler. Remove the inner flange to complete the disassembly.

 When using a sling, stand clear.

## On-Vehicle Mounting of Tires on Titan 5-Piece Rim Assemblies

 Due to the variety of vehicle/equipment configurations and the range of conditions and situations under which on-vehicle demounting (wheel/tire assembly still attached to vehicle or equipment) can occur, proper procedures for blocking, jacking, cribbing of the vehicle/equipment must be done in accordance with the manufacturer's operator's manual, maintenance manual or the information as provided by the vehicle/equipment manufacturer.

Tools Required: Lifting device or boom truck; jack, cribbing, blocking or other items as needed to jack and block the vehicle/equipment per the manufacturer's instructions.

 The task of servicing tires and wheels can be extremely dangerous and should be performed by trained personnel only, using the correct tools and following specific procedures. If you have any doubt about the correct, safe method of performing any step in the demounting, mounting, or inflating process STOP! Seek assistance from a qualified person.

1. Before mounting, always clean all rim components, removing rust and dirt, especially from the lock ring groove and "O" ring groove to insure proper seating and seal. Inspect parts for damage. Replace all cracked, badly worn, damaged and severely rusted components; paint or coat all parts with a rust inhibitor. Double check to be sure correct parts are being assembled. Also inspect the tire for foreign matter.

# Safety Information

 Follow procedures and safety precautions of the paint manufacturer.

 Tires with excessive or uneven wear, cracks, tears, punctures, blisters or other damage may explode during inflation or service. If tire failure potential is suspected, discard the tire and replace with good tire of correct size, type and manufacture for assembly, machine and application.

 Parts that are cracked, worn, pitted with corrosion, or damaged must be discarded and replaced with good parts.

 Do not attempt to rework, weld, heat or braze any rim base or wheel components.





2. Place the inner flange on the rim base, lubricate the tire beads with a vegetable-based lubricant, and position the tire on the rim base using a boom truck or handler.

 Never use petroleum-based lubricant; use vegetable-based lubricant only.

 Stand clear of lifting device.

3. Position the outer flange on the rim base with the help of the boom.

 Stand clear of lifting device.

 Keep fingers clear of pinch points.

4. Place the bead seat band on the rim base with the help of the boom. Be sure driver pocket on bead seat band lines up with pocket on rim base.

 Stand clear of lifting device.

 Keep fingers clear of pinch points.

5. Using the boom to hold the rim components back out of the way, insert a new, lubricated "O" ring into the "O" ring groove

area with an approved vegetable-base lubricant. Snap "O" ring into place by placing in groove on one side stretching like a rubber band and seating on opposite side.

6. Work the lock ring into the lock ring groove.

 Keep fingers clear of pinch points.

7. Check components (lock rings, bead seat and flanges) to make sure that parts are correctly assembled. (NOTE: lock rings should be fully seated in gutter around the circumference. See page S:14.) Insert driver key as required, see page S:15.

 Use a clip-on chuck with and in-line pressure gauge and enough air line hose to permit the person inflating the tire to stand clear of the potential trajectory danger zone. (See p. S:3 & S:10) Stand to the side of the tire during inflation. Inflate to approximately 3 psi and again check for proper engagement of all components. If assembly is correct, continue to inflate to recommended pressure.

 Stand clear of potential trajectory danger zone (see p. S:3 & S:10 illustration).

 If assembly is incorrect, STOP-DEFLATE-CORRECT THE ASSEMBLY-AND REPEAT PROCEDURE.

 Never attempt to inflate an assembly if components are not properly aligned. Never attempt to seat rings or other components or correct components alignment by hammering, welding, heating or brazing while tire is inflated, partially inflated or deflated.

NOTE: A filter on the air inflation equipment to remove moisture from the air line prevents a lot of corrosion. Check the filter periodically to be sure it's functioning properly.

 Never inflate beyond manufacturer's recommended tire pressure.

